

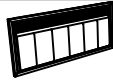









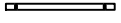

ASSEMBLY INSTRUCTIONS
B1655-115 OBSIDIAN 6/6-6/0 EK/WK HEADBOARD, FOOTBOARD
& SLATS
B1655-335 OBSIDIAN 5/0-6/6 Q/EK SIDE RAILS

Thank you for purchasing this quality product. Be sure to check all packing materials carefully for small parts, which may have come loose inside the carton during shipment. Identify and count all items and compare with the parts list and/or hardware list shown.

NO	COMPONENT	DRAWING	QTY
A	Headboard		1 pc
B	Footboard		1 pc
C	Headboard Leg LSF		1 pc
D	Headboard Leg RSF		1 pc
E	Slats		4 pcs
F	Slats Support Leg		8 pcs
G	Side Rail		2 pcs
H	Bottom Stretcher		1 pc

NO	COMPONENT	DRAWING	QTY
1	JCBC M6 x 1 3/16" Blk		6 pcs
2	Spring Washer 1/4" Blk		6 pcs
3	Flat Washer 1/4"IDx4/8"OD Blk		6 pcs
4	Allen Key M4 x 2 9/16" Blk		1 pc
5	Allen Key M5 x 2 9/16" Blk		1 pc
6	Flat Head Chipboard Screw M4 x 1 2/8" Rbw		12 pcs

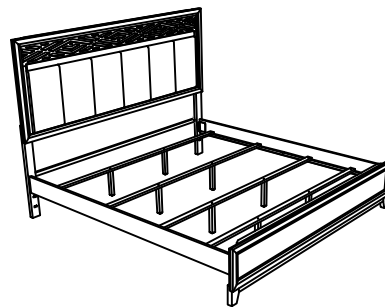

STEP 1 : Attach Head Board Leg (C & D) to Head Board (A) as shown using JCBC BOLT (1) with Spring Washer (2), Flat washer (3) and securing with Allen Key (4).

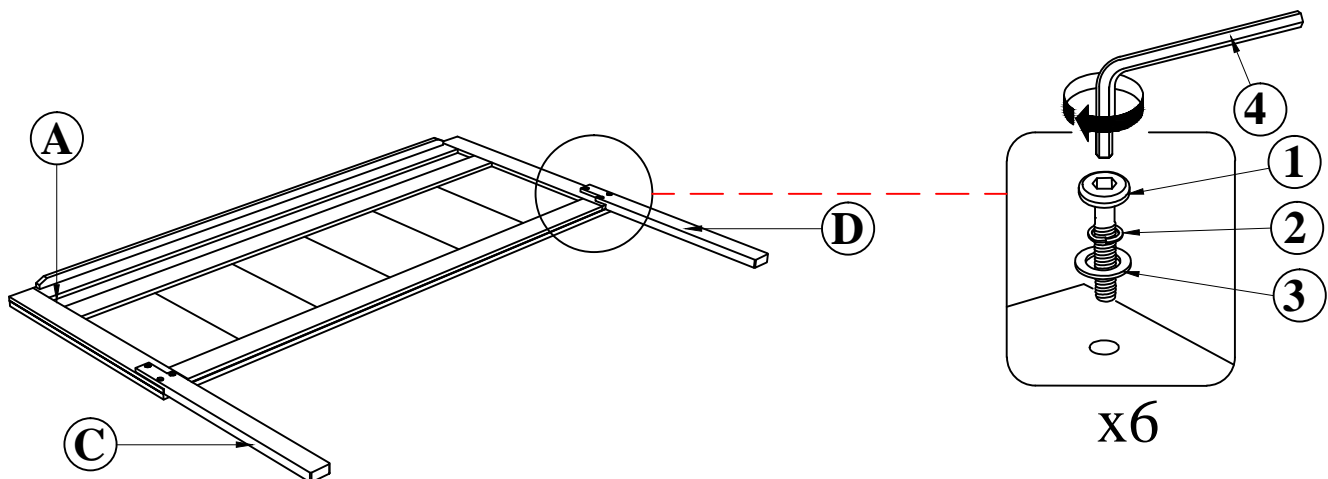

STEP 2 : Hook side rail (G) to Headboard (A) closely and push down to fit. repeat step 2 with other end of rail to hook onto Footboard (B).

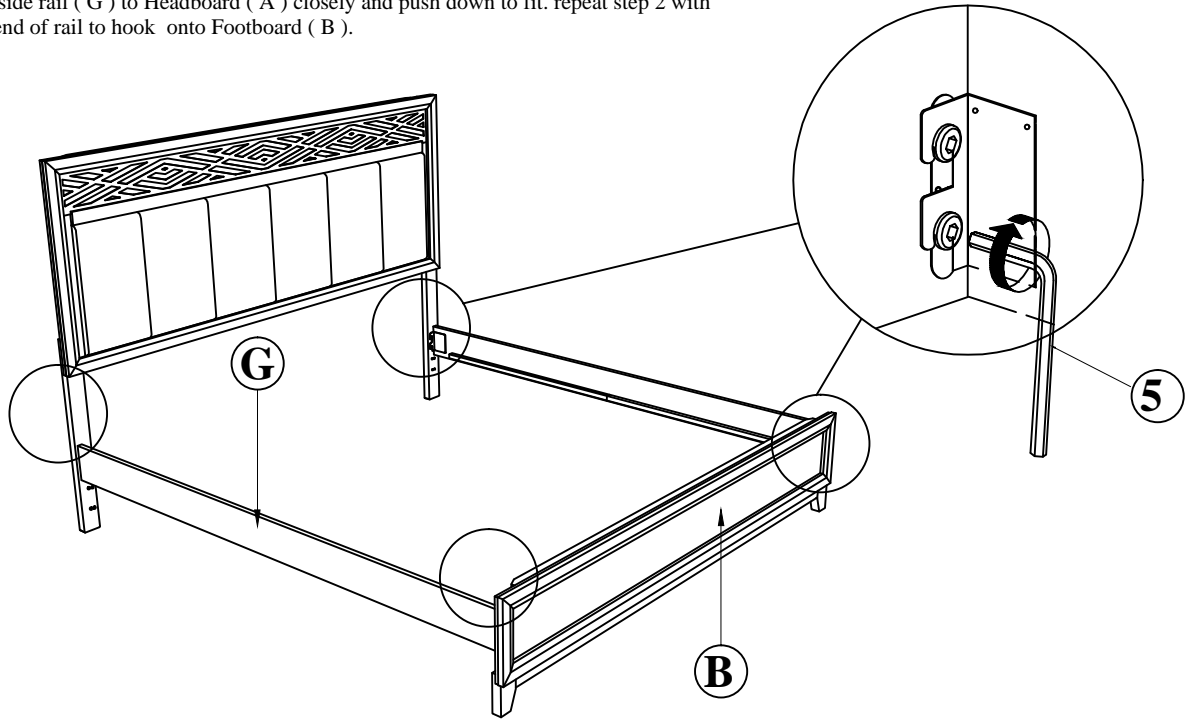

STEP 3 : Tighten the 4 Corner with Allen Key (5) . Fix the Bed Slat Support Leg (F) , to Bed Slat (E) as shown . Install the bed slat (E) to side rail (G) and tighten with Csk Screw (6) as per diagram shown.
 (NOTE: THE SETUP MUST DONE AT THE DECIDED LOCATION FOR THE BED TO OBTAIN PERFECT STABILITY)

STEP 3.1 :

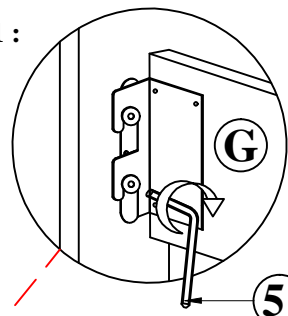

STEP 3.4 :

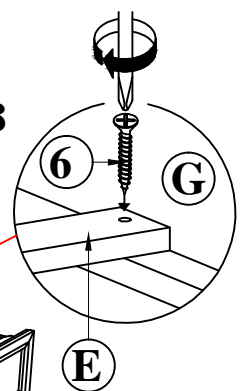

STEP 3.2 :

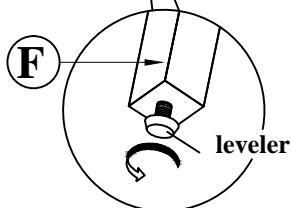
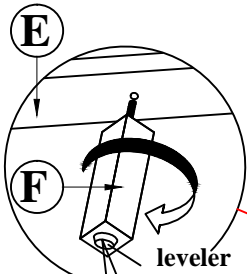

STEP 3.3 :

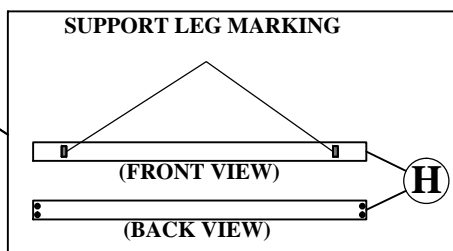
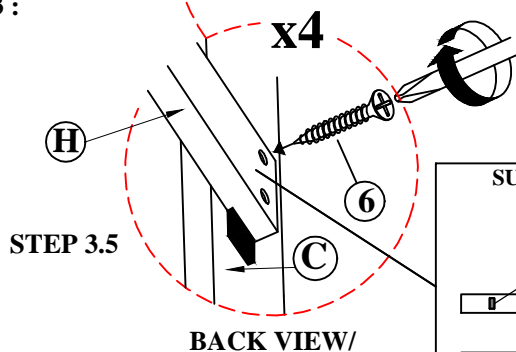

Push the side rail (G) meet with wooden slat (E) and fix the CSK screw (6) by using the Screw Driver (NOT PROVIDED).

COMPLETED ASSEMBLY