



# ASSEMBLY INSTRUCTIONS







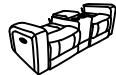

LINTON LEATHER COLLECTION

ITEM#: L1721-25P1

DESCRIPTION : LINTON LEATHER CONSOLE LOVESEAT  
W/ PWR FR

Thank you for purchasing this quality product. Be sure to check all packing materials carefully for small parts, which may have come loose during shipment. Identify and count all items and compare with the parts list shown below. It is recommended to have two people during assembling and to remove the back and base of the furniture out from the box.

**Please follow the drawings below to assemble the item**

Parts List			
NO.	DESCRIPTION	SKETCH	Q'TY
A	Seat		1 PC
B	Left Backrest		1 PC
C	Console Backrest		1 PC
D	Right Backrest		1 PC
E	Left Wing		1 PC
F	Right Wing		1 PC
G	Knob Screws		2 PCS
H	Plug		1 PC
I	Transformer		1 PC

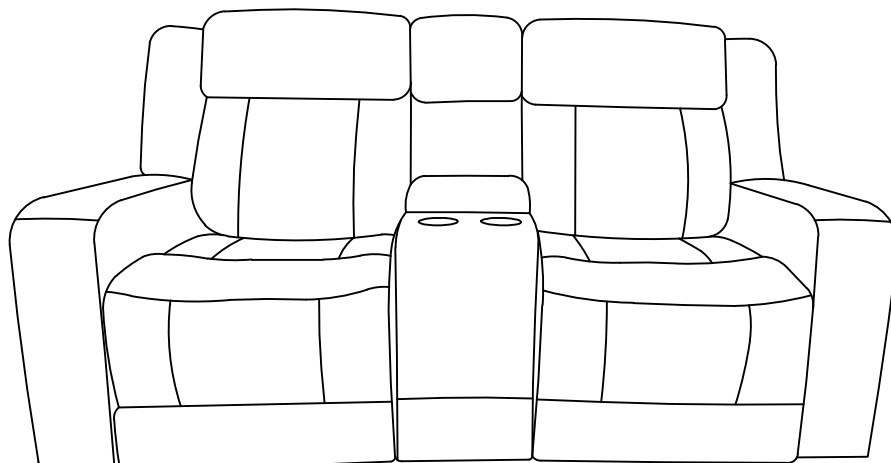

All images shown are for illustration purpose only.  
Actual product may vary due to product enhancement.

# ASSEMBLY INSTRUCTIONS

LINTON LEATHER COLLECTION

ITEM#: L1721-25P1

DESCRIPTION : LINTON LEATHER CONSOLE LOVESEAT  
W/ PWR FR

## Step 1:

Attach Backrest (B/D) to the Seat (A).  
Attach the Left Wing (E) and Right Wing (F) to Backrest (B/D).

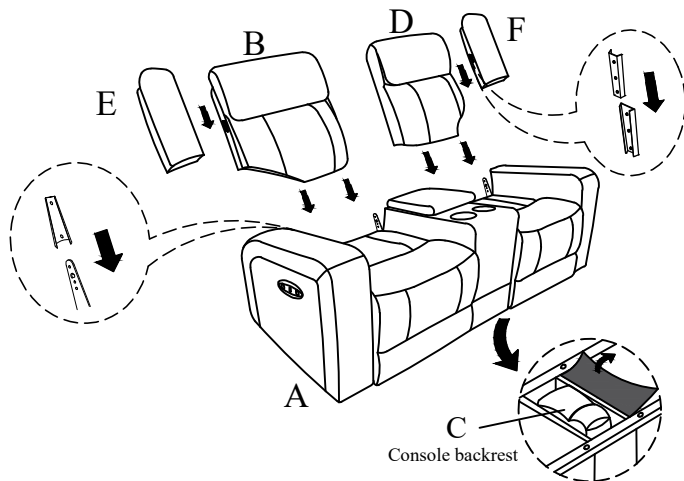

## Step 2:

Place the console Backrest (C) in the right location and then attach to the Seat (A) by turning the Knob Screws (G) counterclockwise.

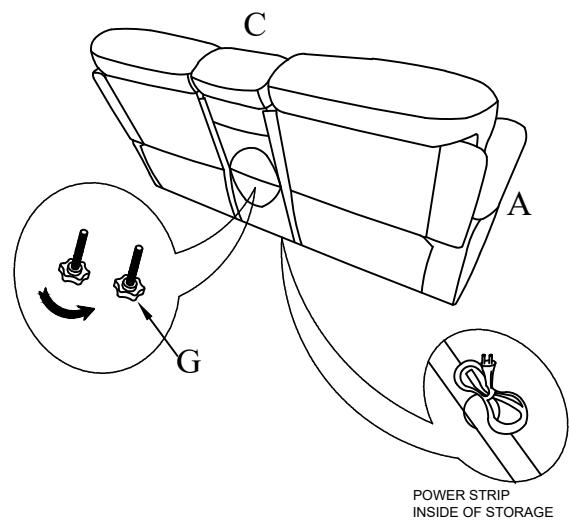

## Step 3:

Connect the power wire under the Armrest frame to the power source through out the Transformer (I) and The Plug (H).

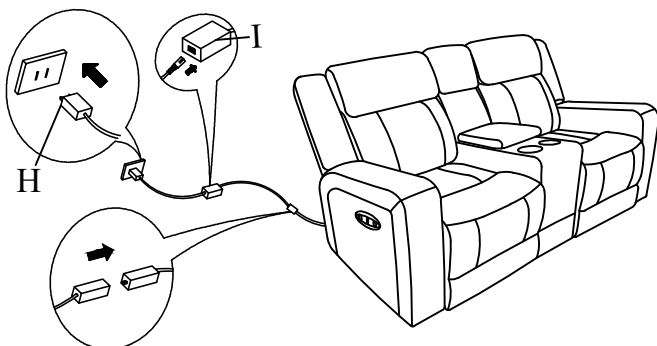

## Step 4:

Open the Footrest by pressing the power button on/off.

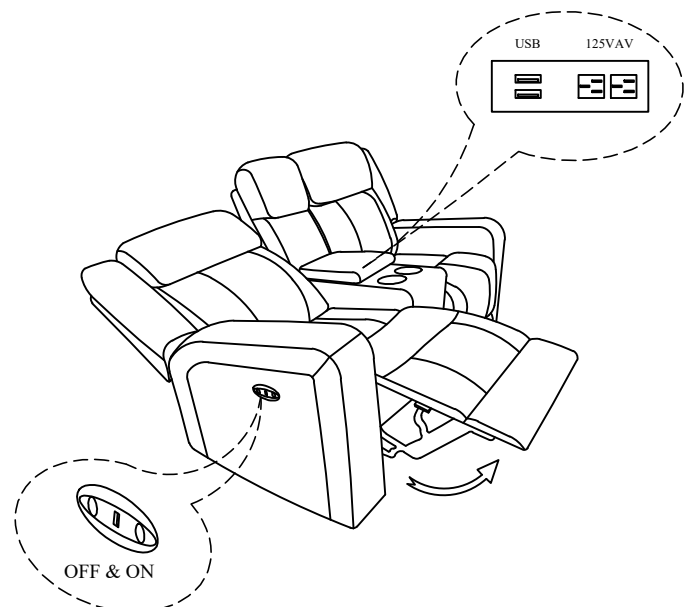

All images shown are for illustration purpose only.  
Actual product may vary due to product enhancement.