

ASSEMBLY INSTRUCTIONS

TAMARACK

BB044-115/335 KING BED

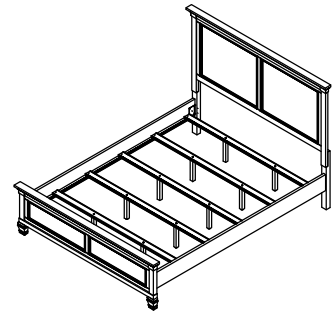

Thank you for purchasing this quality product. Be sure to check all packing materials carefully for small parts, which may have come loose inside the carton during shipment. Identify and count all items and compare with the parts list and/or hardware list shown below.

IMPORTANT NOTE :

Place all wooden parts on a clean and smooth surface such as a rug or carpet to avoid the parts from being scratched. Check to be sure that you have all parts and hardware. Remove all wrapping materials, including staples & packing straps before you start to assemble. Do not tighten all screw/bolts until all completely assembled. Keep all hardware parts out of reach of children.

DO NOT TIGHTEN BOLTS/SCREWS UNTIL ALL COMPLETELY ASSEMBLED.

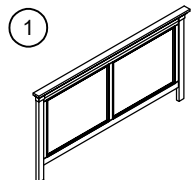
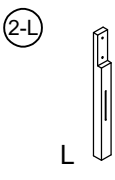
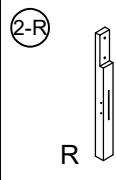
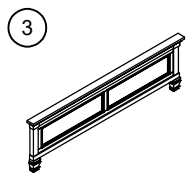
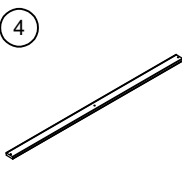
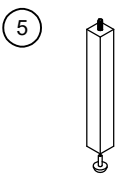
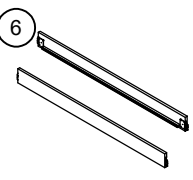
PARTS LIST						
						
HEADBOARD: 1PC	POST-LEG LEFT: 1PC	POST-LEG RIGHT: 1PC	FOOTBOARD: 1PC	SLAT: 5PCS	SUPPORT-LEG: 10PCS	RAIL: 2PCS

HARDWARE LIST			
NO.		DESCRIPTION	QTY
A		JCBB BOLT M8 x 40mm	4 PCS
B		SPRING WASHER M8	4 PCS
C		FLAT WASHER M8 x 16mm	4 PCS
D		ALLEN KEY M5	1 PC
E		CSK SCREW M4 x 32mm	10 PCS

