

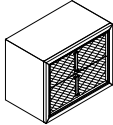







Thank you for purchasing this quality product. Be sure to check all packing material carefully for small parts ,which may have come loose inside the carton during shipment. Identify and count all items and compare with the parts list and/or hardware list shown below.

PARTS LIST			
NO.	Description	Sketch	Q'ty
1	NIGHTSTAND		1PC
2	REAR LEG (Left)		1pc
3	FRONT LEG (Right)		1pc
4	REAR LEG (Left)		1pc
5	REAR LEG (Right)		1pc

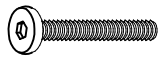
HARDWARE LIST			
NO.	Description	Sketch	Q'ty
A	BOLT Ø5/16 " x 1-1/2"		4PCS
B	DPRING WASHER Ø5/16 "		4PCS
C	FLAT WASHER Ø5/16 "		4PCS
D	ALLEN KEY 4x58x22mm		1pc
E	TIPPING RESTRAINT		1SET

Step 1

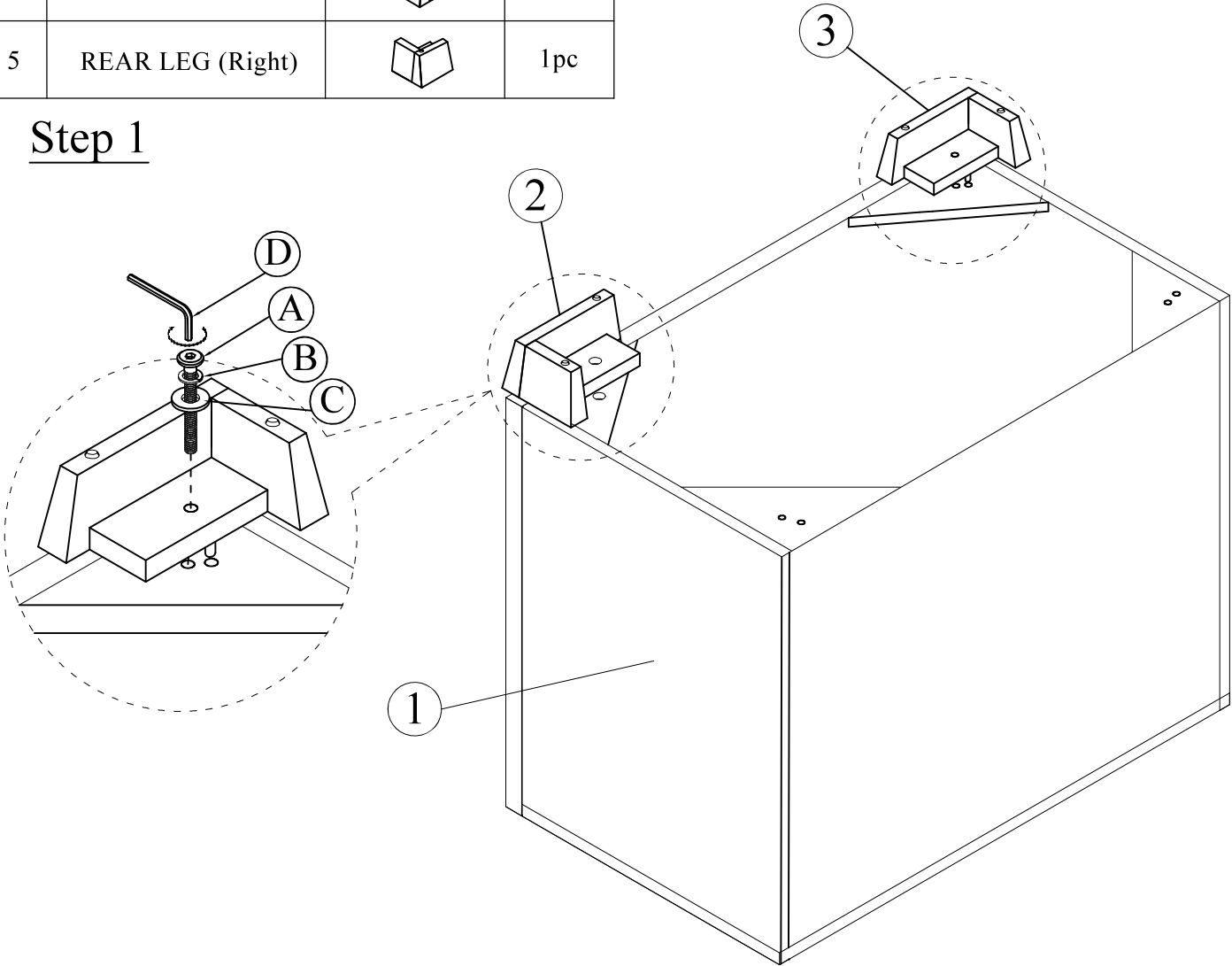

Step 2

