

Assembly Instructions

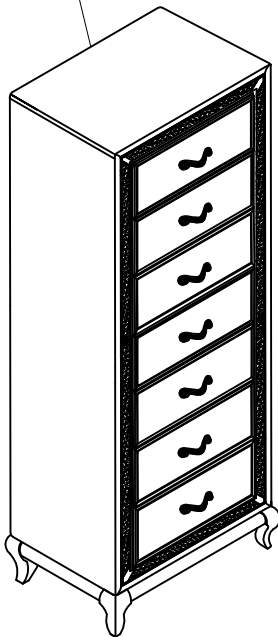

PARK IMPERIAL LINGERIE CHEST/ B0931B/P/W-074

Thank you for purchasing this quality product. Be sure to check all packing materials carefully for small parts, which may have come loose inside the carton during shipment. Identify and count all items and compare with the parts list and hardware list shown below.





★ Remark : There is a tip restraint kit provided on the back of this product. Please read the directions thoroughly and install immediately when placed in home.



PARTS LIST

NO	DESCRIPTION	SKETCH	QTY
1	LINGERIE CHEST		1 PC
2	LEG		4 PCS

HARDWARE LIST

NO	DESCRIPTION	SKETCH	QTY
A	JCBB BOLT - M8 x 60mm		4 PCS
B	SPRING WASHER - M8		4 PCS
C	FLAT WASHER - M8		4 PCS
D	ALLEN KEY - M5		1 PC

STEP 1

- Withdraw the leg pack on the last bottom drawer.

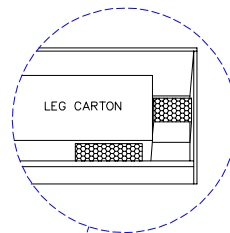

COMPLETE ASSEMBLY

PLACE WOOD PARTS ON A CLEAN NON-ABRASIVE SURFACE

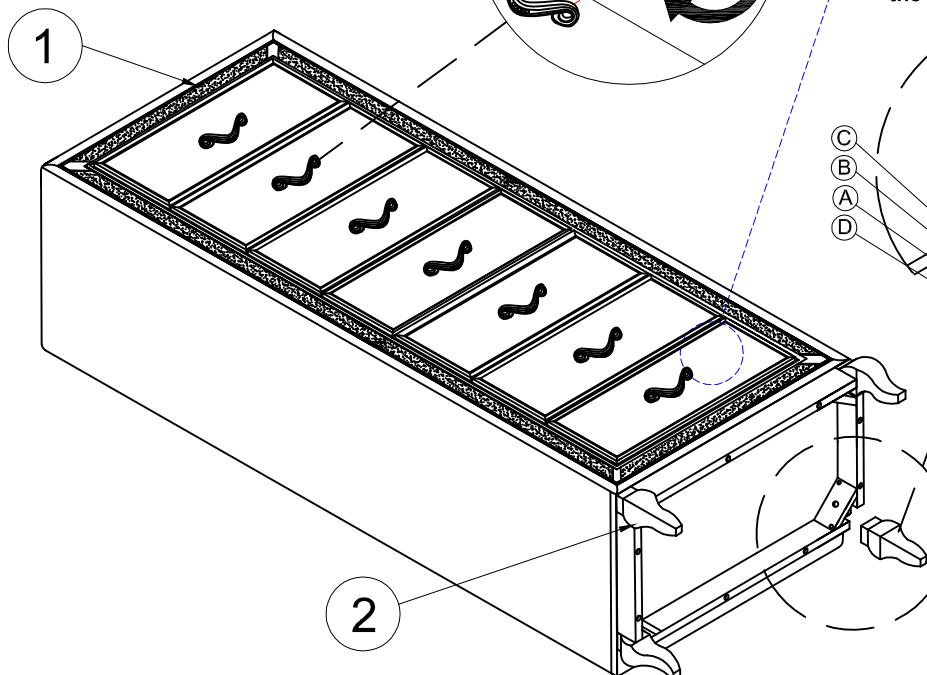

STEP 2

- Tighten the JCBB Bolt (A) through the LEG using allen key (D)

